

TWIST
2-PIECE SAFETY RAZORS
operating manual
and safety instructions

Content

- 1 About this document
- 2 Notes on safety
- 3 Potential hazards
- 4 Assembling, changing blades and storage of your MÜHLE Safety Razor
- 5 Scope of delivery, transportation, storage and installation
- 6 How to use your MÜHLE Safety Razor properly
- 7 Accessories and spare parts
- 8 Maintenance, cleaning and service
- 9 Returning the razor to MÜHLE
- 10 Disposal

1 About this document

It is imperative that you read this operating manual completely and carefully, including the safety instructions. Improper use can cause serious injury. Always keep this operating manual to hand – do not throw it away!

! WARNING

Read this manual before using this product. Never let others use the razor without having read the manual. Make sure the manual is included when the razor is passed on or sold to other users. Failure to follow the instructions and safety precautions in this manual can result in serious injury. Keep this manual in a safe location for future reference.



This manual applies to the following razors

2-piece Safety Razors with closed comb

2-piece Safety Razors with open comb

For more information about selecting the correct MÜHLE Safety Razor for your needs, go to:

www.muehle-shaving.com

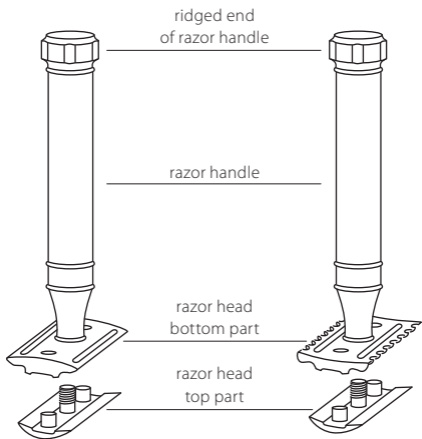

R 89 TWIST

R 41 TWIST

2-piece razor
with closed
comb

2-piece
razor with
open comb

2 Notes on safety

⚠ WARNING

Failure to observe the safety instructions can result in serious injury.

- > Always observe the safety instructions in this manual.
- > Read all instructions before using this razor.

MÜHLE Safety Razors are not intended for use by persons with impaired physical, sensory or mental abilities or lack of experience and knowledge, unless they have been supervised or have received instruction concerning the use of the razor and its accessories by a person responsible for their safety.

3 Potential hazards

Although the MÜHLE Safety Razor is safe and reliable when used and cared for properly, operating the MÜHLE Safety Razor entails a number of safety hazards that should be avoided.

Always use your MÜHLE Safety Razor properly.

You should shave at a 30-degree angle, without applying strong pressure on the area being shaved (see Section 6). For more information about the proper use of your MÜHLE Safety Razor, go to:
tutorial.muehle-shaving.com

To avoid bacterial infections, only use blades that have been stored in cartridges. For reasons of hygiene and to achieve best results, the blades should be replaced after five (5) shaves (or five (5) days).

3.1 Cuts to the skin

Check the razor blade for damage or deformation before use. Your skin may be injured if it is damaged or deformed.

⚠ CAUTION

**Danger of cuts to the skin.
Serious injuries and severe bleeding.**

- > Check the razor blade for damage or deformation before use.
- > Read 4.1 (Instructions for changing the blade) and 6.1 (Instructions for use) carefully.



3.2 Razor burn

If your skin appears abnormal after shaving, stop using the razor and consult a dermatologist. Continued use may worsen your skin condition.

⚠ CAUTION

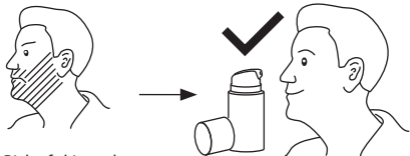

**Risk of skin rash.
Severe reddening and burning skin.**

- > Use a sterile blade.
- > If your skin reacts with irritation, apply a soothing after shave balm.

3.3 Razor bumps

Do not apply strong pressure to the skin. Avoid sideways movements of the razor and excessive shaving of the same area of skin. Allow the razor to glide over your skin, applying gentle pressure according to the razor's net weight. Avoid areas of skin with spots or pimples. Do not use the razor on sensitive or delicate skin (this may cause injury) or if you are prone to allergies (this may cause an allergic reaction).

⚠ CAUTION



Risk of malfunction of razor

Risk of allergies appearing

> Avoid sideways movements and excessive shaving of the same area of skin.

4 Assembling, changing blades and storing your MÜHLE Safety Razor

Make sure that the razor head and handle are firmly attached to each other, but only tighten the screw such that it can be unscrewed without much effort.

Make sure your hands are clean and dry.

⚠ WARNING



BE VERY CAREFUL! Blades can cause serious injuries and severe bleeding.

- > Use your thumb and index finger to grip the razor blade by its short, blunt sides.
- > Never touch the sharp edges of blades!
- > Wash and dry your hands carefully before assembling the razor handle, razor head and blade, and hold blades firmly to avoid dropping them.
- > Firmly attach the razor head and handle to each other.

4.1 Changing the blade

The protrusion of the blade on the narrow sides of the razor head is not a defect of the product but is used for insertion/removal of the blade. To safely change blades:

The MÜHLE R 89 TWIST and R 41 TWIST razors are 2-piece Safety Razors. The razor head bottom part is connected with the handle and must not be removed from the razor handle. **1.** Put the razor in your hand, with the razor head showing down. Make sure the razor head touches a table. **2.** Hold the razor handle in one hand and use the other hand to unscrew the razor head top part by turning the ridged end of the razor handle to the left. **3.** Let the razor head top part rest on the table and take off the handle part. Remove the used blade if inserted. **BE VERY CAREFUL!** Use your thumb and index finger to grab the razor blade at its short, blunt sides. Never touch the blades on its sharp edges! **4.** Take the new razor blade out of the cartridge. **BE VERY CAREFUL!** Use your thumb and index finger to grab the razor blade at its short, blunt sides. Never touch the blades on its sharp edges! **5.** Let the razor blade slide onto the two pins and the center thread of the razor head top part. **BE VERY CAREFUL!** **6.** Place the handle on the two pins and center screw on the razor head top part. Turn the ridged end of the razor to the right in order to tighten the razor. Make sure to only tighten the screw to the end that it can be unscrewed without much torque (see possible problems which can occur under 6.1) **7.** Overview the razor again before every use. Check the following points: > Does the razor head top part show any dents or defects? > Is the center screw on the razor head top part firmly attached to the razor top part? Are any cracks visible? Is it bend or the thread worn off? > Are all pieces properly connected and fastened? > Is the razor head top part firmly connected with the razor handle? > Do not use the razor if any of the mentioned faults occur or any parts are loose! **8.** You are now ready to start shaving with your MÜHLE Safety Razor!

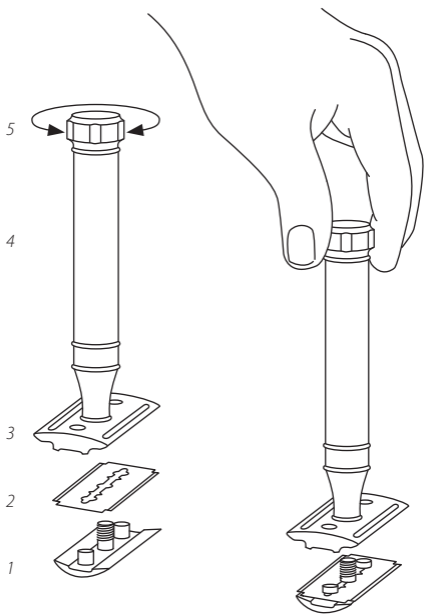

- 1 razor head top part
- 2 razor blade
- 3 razor head bottom part
- 4 razor handle
- 5 ridged end of razor handle

4.2 Storage

Make sure to store your razor in a safe and dry place where it is out of reach of children and animals. Children are not able to handle a razor with the necessary care. This can cause serious accidents and injuries. Children and also animals could bite on the razor, cut themselves or swallow the blade.

⚠ DANGER

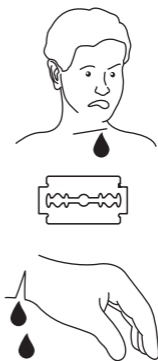
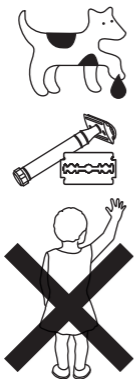

Danger of little children not handling a razor with the necessary precaution.

Serious injury or death!

- > Store razor blades in safe cartridges.
- > Keep the razor and especially the blades out of reach of children and animals.

5 Scope of delivery, transportation, storage and installation

5.1 Unpacking/checking equipment and scope of delivery

After unpacking, please check the MÜHLE Safety Razor and its optional accessories for completeness and for damage. If a part is missing or damage has occurred, inform your vendor immediately.

5.2 Guidelines for safe transportation

Always ensure that your razor is safely packed when transporting it (e. g. in a cartridge, box, etc.). Always remove the blade from the razor to transport both separately, ideally in boxes/cartridges provided. Transporting loose razors in a bag may cause severe accidents and injuries. Alternatively install the MÜHLE blade guard (item code KSR) in order to avoid accidents and injuries.

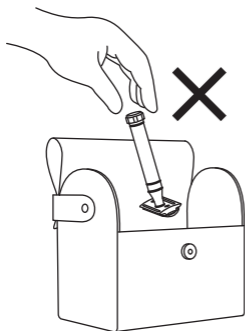

Item Code KSR

6 How to use your MÜHLE Safety Razor properly



6.1 Instructions for use

Make sure that your skin is clean. If the hair is too long and thick, it should be trimmed before shaving with the MÜHLE Safety Razor. Moisten the area to be shaved, preferably with warm water, and lather it thoroughly with a shaving brush. Always use a high-quality moisturising shaving cream or shaving soap. This will allow the blade to glide more easily over the skin. Clean the cutters and guards with water or a brush to remove the hair.

We recommend the MÜHLE skin care line for a sensual and refreshing wet shave.

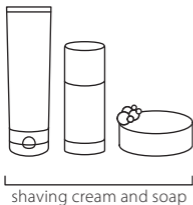

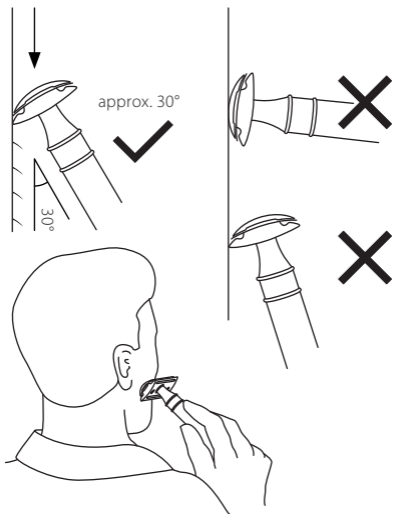

Hold the safety razor at a sharp angle (approx. 30°) to the skin. Start with the cheeks (or other area to be shaved) and allow the razor to glide over the skin, applying gentle pressure. Always start to shave in the direction of the hair growth (with the grain). When shaving curved areas (like your neck), pull the skin tight with your free hand. Do not be discouraged by small cuts or grazes. Once you have familiarised yourself with the razor, they will rarely occur. Shave each area only once. Please note that different blades may have different levels of sharpness. See 3 – 3.3 to find out more about potential hazards.

6.2 Problem: poor shaving performance

If the shaving performance is reduced, this can occur for the following reasons:

The razor head or blade is slightly rusty or worn.

Stop using the MÜHLE Safety Razor and replace the razor head or blade. Continued use with rusty equipment can cause inflammations.

Long hairs are obstructing the razor head.

Clean the cutters and guards with a brush to remove the hair. If the hair is too long and thick, it should be trimmed before shaving with the MÜHLE Safety Razor.

The razor head is dirty.

The MÜHLE Safety Razor has not been cleaned well enough or has not been cleaned for a long time. Clean the shaver thoroughly before continuing shaving.

The razor head is damaged.

Please contact our customer service.

The blade is not properly inserted in the razor.

Remove the blade and reassemble it with the razor head. The choice of blade is a matter of personal choice. If the results are still not satisfactory after adjusting the blade, try a different brand of blade (see information provided in 4.1).

7 Accessories and spare parts

All maintenance, repairs and replacements must be completed by qualified persons authorised by MÜHLE, using MÜHLE spare parts. The user is responsible for any risk arising from unauthorised repairs or accessories.

MÜHLE razor blades and razor head spare parts available

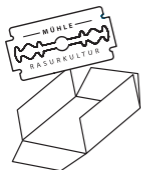

Item Code K1



Item Code R 89 OT



Item Code R 41 OT

MÜHLE shaving brushes and perfect fitting holders available separately.

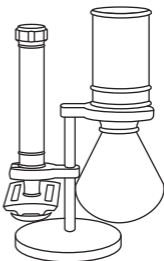
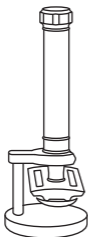

NOTICE

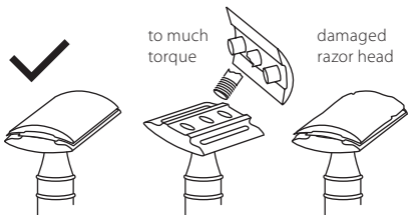

Risk of destruction of the MÜHLE Safety Razor. Reduced shaving results and destruction of the razor.

- > Do not excessively tighten the thread on the razor head.
- > Avoid dropping the razor.

8.1 Maintenance and service

Never modify, disassemble or repair the MÜHLE Safety Razor. This may cause unexpected injuries and damage/destruction of the appliance. Contact the store from which you purchased the MÜHLE Safety Razor or a qualified service centre for repair.

The use of different types of blades may alter the performance of the razor and may worsen the shaving results. Some blades may lose their sharpness after a short time. Dropping the razor or pulling the razor's thread too tight may cause a breaking of the thread, deformation or damage of the surface.

8.2 Cleaning and disinfection

Make sure to always remove the blade from the razor before cleaning it! A MÜHLE Safety Razor is suitable for cleaning under running tap water. Regular cleaning ensures improved shaving performance. Rinsing the razor head under running tap water after each shave or using a mild detergent is an easy and fast way to keep it clean. Do not under any circumstance use benzine, thinner, acid or vinegar neither detergent that includes acid to clean the razor! This can lead to malfunctions, cracks or discoloration of the parts. Rinse the blade under running water and dry it carefully with a towel.

To avoid bacterial infections, only use blades that were stored in cartridges. For reasons of hygiene and to achieve optimal results, the same blade should only be used for five shaves.

⚠ WARNING



Risk of cuts and bacterial infections as well as injuries, severe bleeding on hands and malfunction of the razor.

- > Always remove the razor from the blade while cleaning the equipment.
- > Do not under any circumstances use benzine, thinner, acid or vinegar to clean the razor!

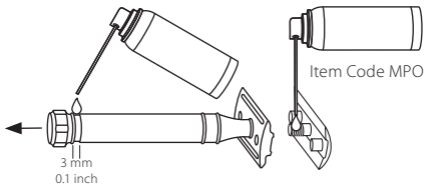

The TWIST razor has a ridged turning knob at the razors end. From time to time unscrew the razor top plate, , pull out the ridged knob (it snaps back in position) and spray some MÜHLE Maintenance Oil in the gap (alternatively use e. g. KW-40). Wipe off any oil on the handle before using the razor again.

NOTICE

Never try to dismantel the razor handle!

The turning mechanism is fixed with the handle.

9 Returning the razor to MÜHLE

If you return the product to MÜHLE or your distributor, make sure to specify the following information:

- MÜHLE product type and serial number (or serial number used by your distributor)
- Include a copy of the sales receipt
- Name and address of the distributor from which you purchased the MÜHLE product
- Exact description of malfunction, defect or damage which was caused by a defect
- Your full address and contact information (phone number, email address)

10 Disposal

If recycling is an available option, please dispose of the different packaging materials (paper, metal, etc.) for recycling. Broken blades should be safely disposed of in suitable cartridges or protective paper. Throwing away a blade without protective covering may cause serious injury.

⚠ WARNING

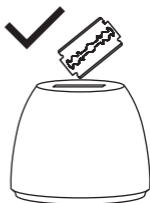
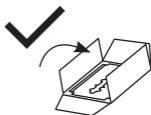

Item Code BB

Risk of sustaining cuts.

Serious cutting injuries with severe bleeding.

> Put the used blade in a protective cover (cartridge) before throwing it away.

Supplier

Hans-Jürgen Müller GmbH & Co. KG
(referred to as "MÜHLE Shaving")

Address

Hauptstraße 18
08328 Stützengrün (Germany)

Product

MÜHLE Safety Razor TWIST

Type

2-piece Safety Razor with closed comb (R 89 TWIST)
2-piece Safety Razor with open comb (R41 TWIST)



#safetyrazor #rasurkultur

Translation

tutorial.muehle-shaving.com



MÜHLE Shaving

Hans-Jürgen Müller GmbH & Co. KG
Hundshübel Hauptstraße 18
08328 Stützengrün (Germany)
Phone +49 (0)37462-652-0
Fax +49 (0)37462-652-18
info@muehle-shaving.com